

SCHEMA IDRAULICO
PLUMBING CONNECTION

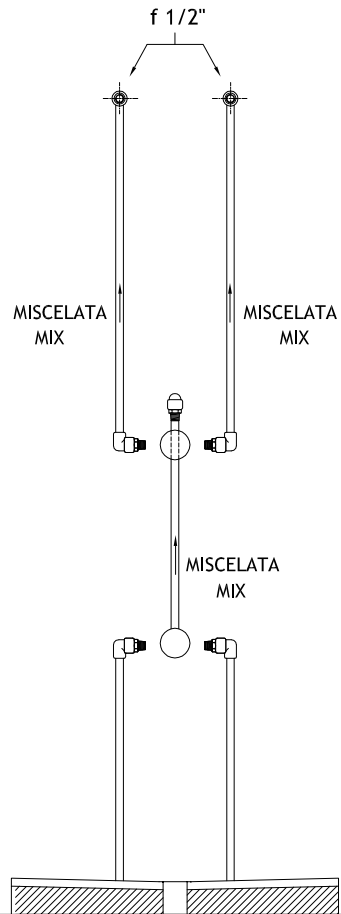

INDICAZIONI PER IL
RIVESTIMENTO
DETAILS FOR WALL
COVERING

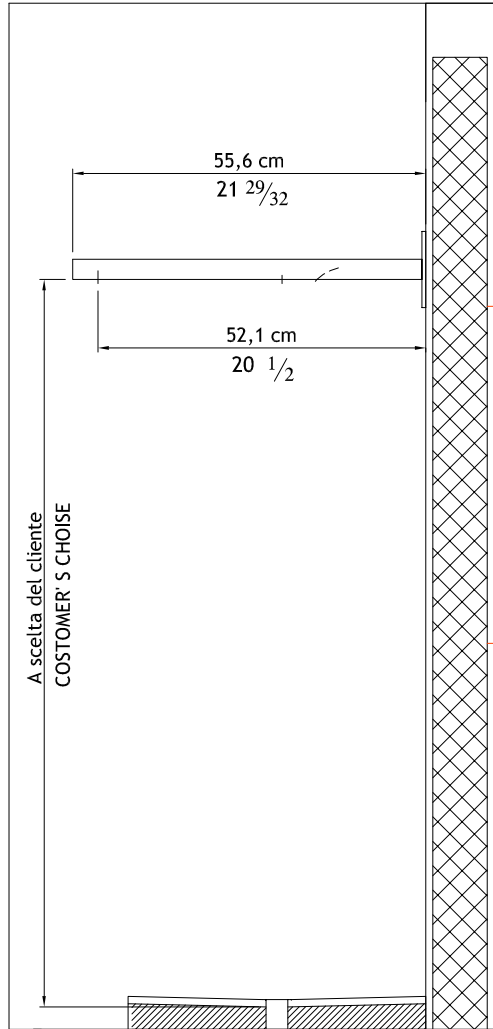
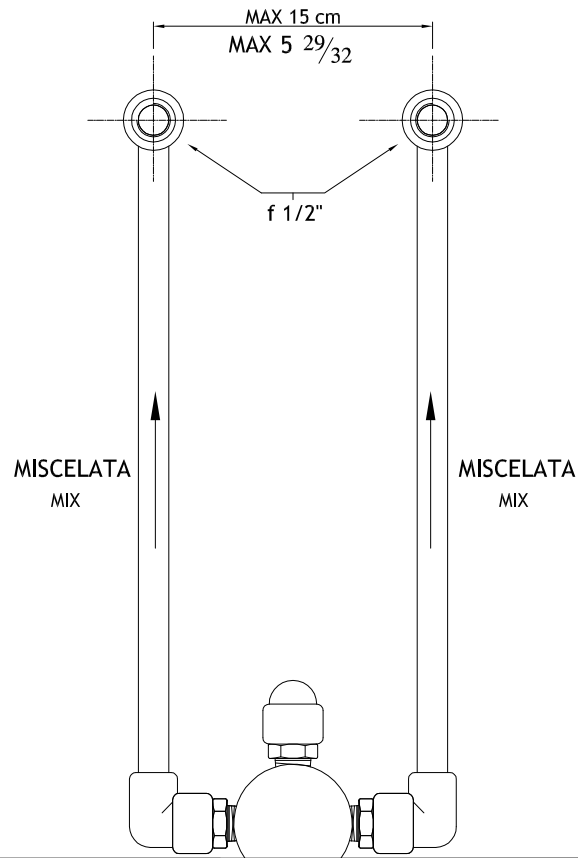

VISTA FRONTALE
FRONT VIEW

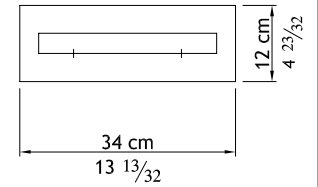

ATTENZIONE

**VERIFICARE CHE L' IMPIANTO SIA PREDISPOSTO A MURO CORRETTAMENTE
COME INDICATO DALLE FIGURE.**

WARNING

CHECK THAT PLUMBING CONNECTIONS ON THE WALL ARE AS PER DRAWINGS ABOVE

MGS Progetti srl

Corso Milano, 189 - 28883 Gravellona Toce (VB) - Italy

www.mgsprogetti.com - E-mail: info@mgsprogetti.com - Tel.: +39 0323 865218 - Fax: +39 0323 865215

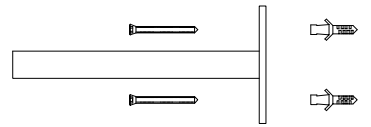
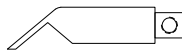
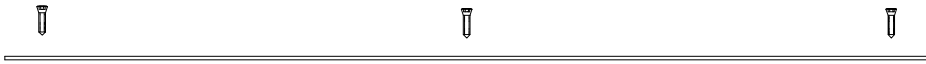

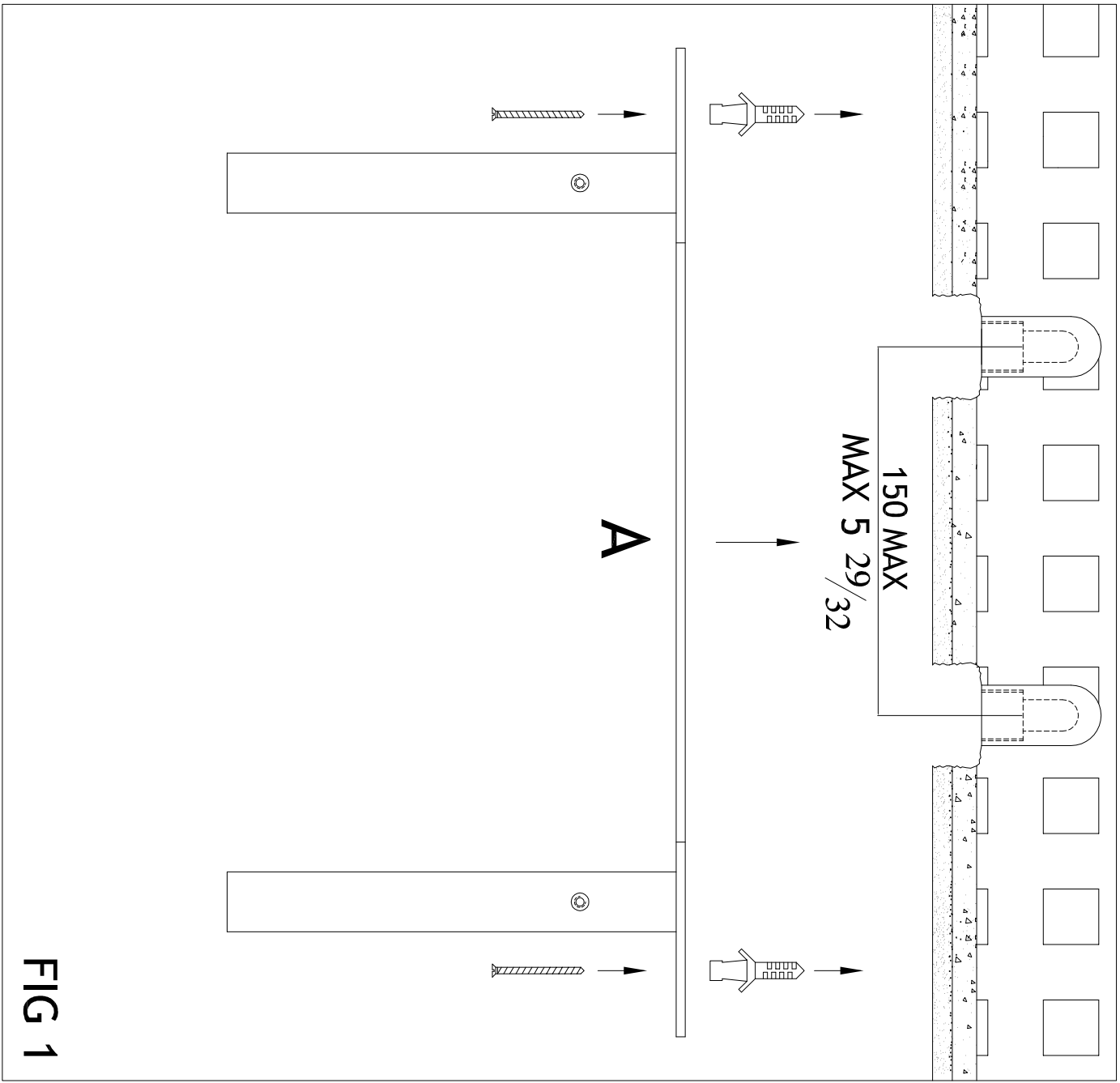
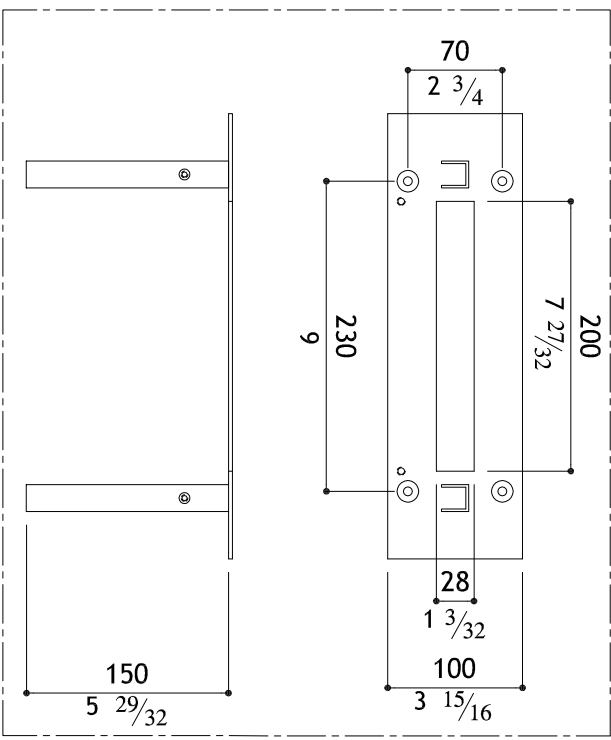
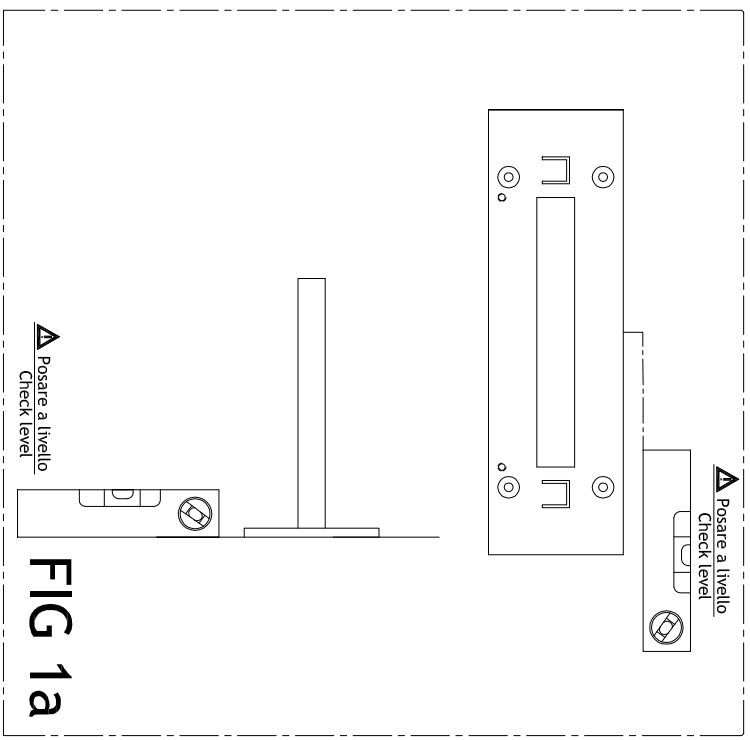
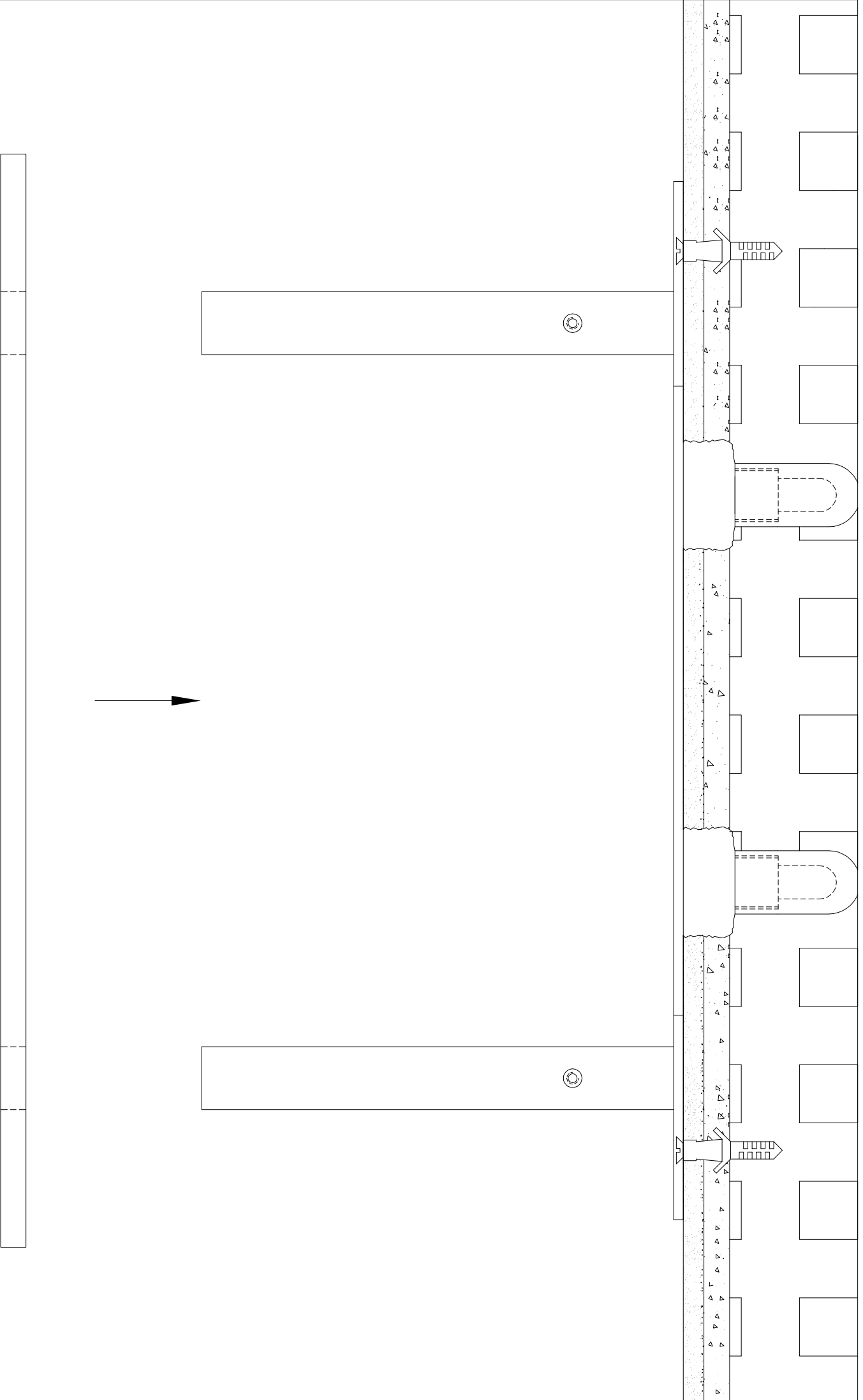

FIG 1





B

FIG 2

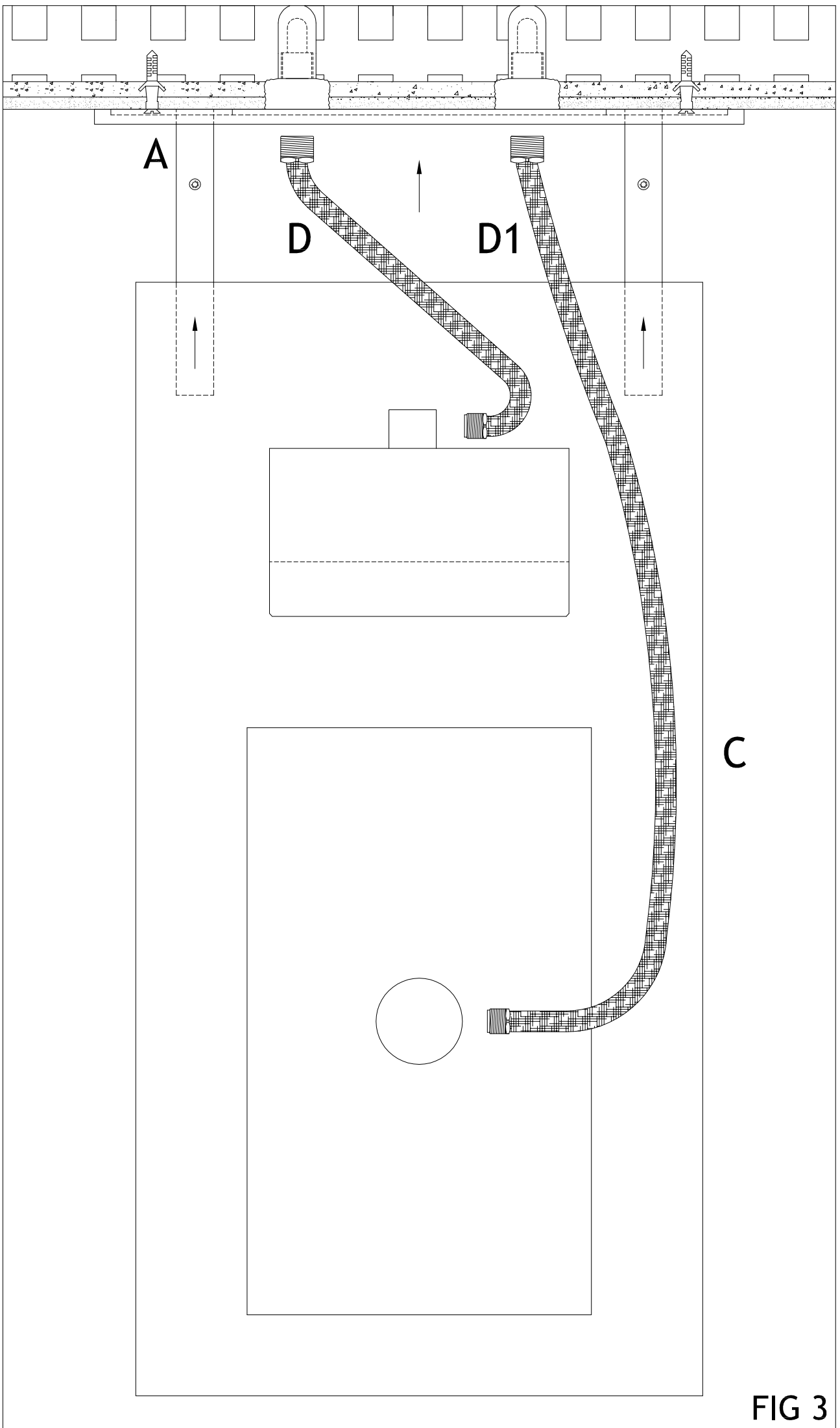
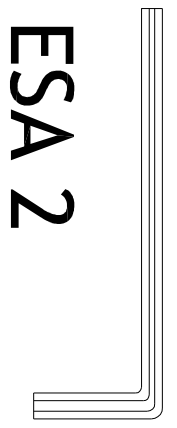
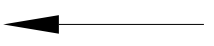

FIG 3



E



C

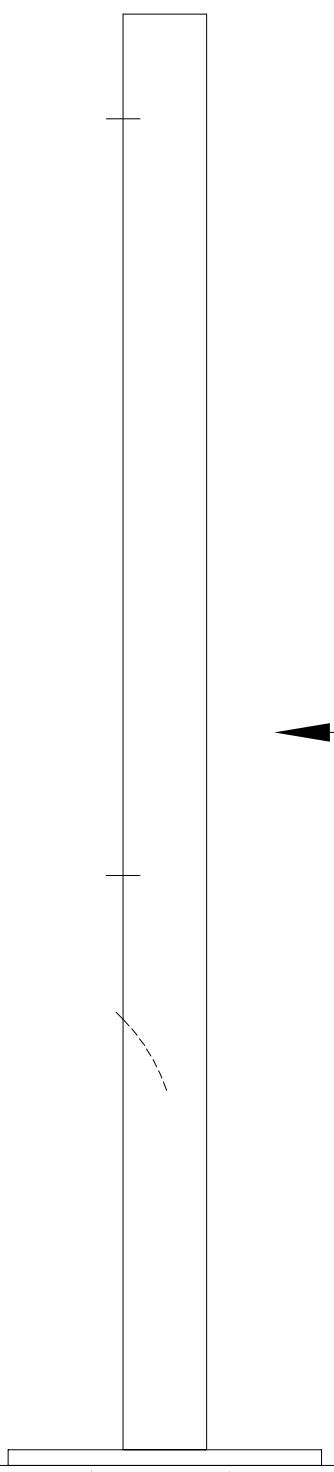
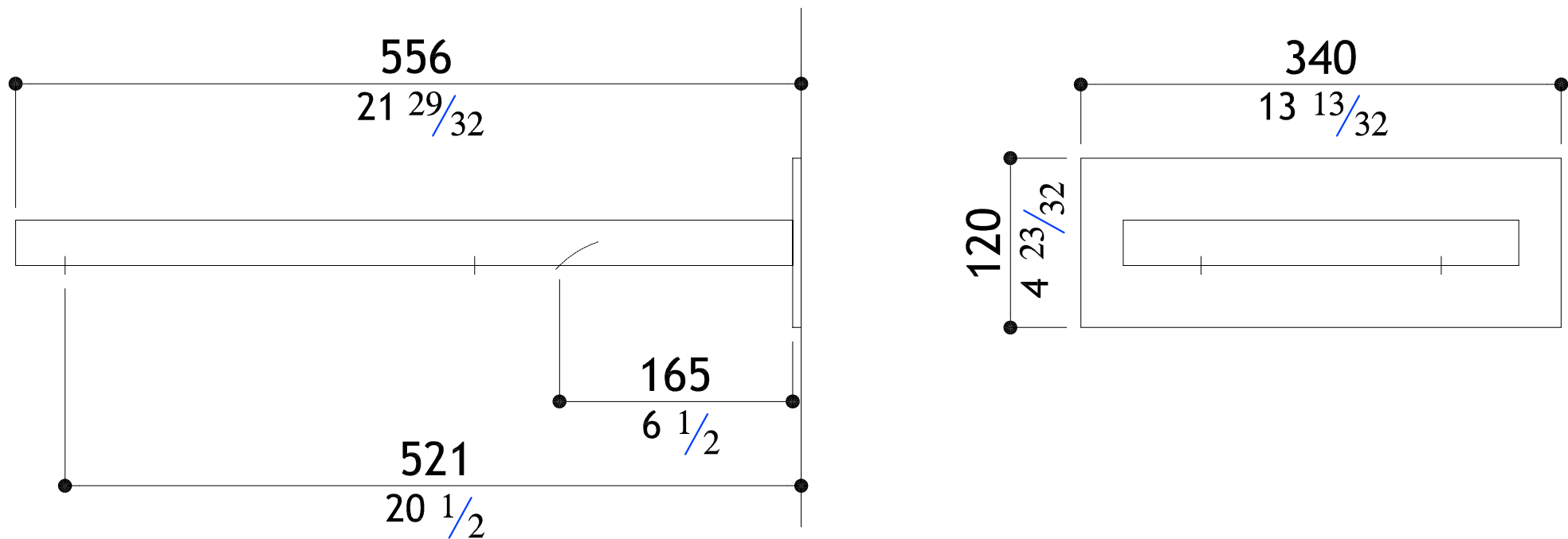

FIG 4



MGS Progetti srl

Corso Milano 189 28883 Gravellona Toce (VB) Italy
Tel.: +39 0323 865218 Fax: +39 0323865215
www.mgstaps.com E-mail: info@mgstaps.com